

	A mm	B mm	C mm	D mm	E mm	F mm	G mm	H mm
NE2250	250/500	2000	1200/1800	650/1250	1000	500	700	250
NE2500	250/550	2500	1820/2595	1350/1750	1500	760	970	400
NE3000	250/550	3000	2080/2855	1450/2190	1500	760	970	400
NE3500	250/550	3500	2340/3250	1670/2500	1750	760	970	400
NE4000	250/480	4000	2820/3250	2130/2900	2050	760	970	400

TRAMOGGE VIBRANTI SERIE "TRAV"

	A mm	B mm	C mm	D mm	E mm
TRAV 125	1340	960/1020	1265/1325	680	
TRAV 250	1600	1060/1120	1229/1334	810	
TRAV 500	1900	1060/1120	1740/1800	810	1500

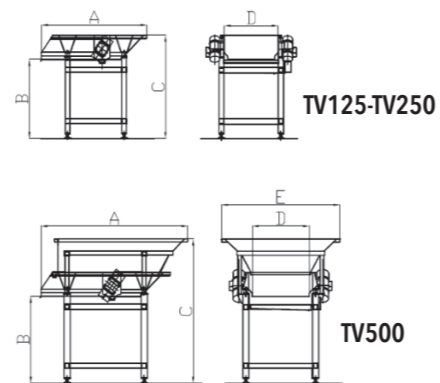

TAVOLI A NASTRO SERIE "NS"

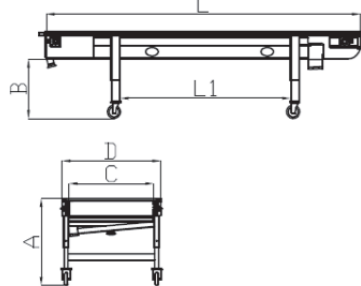

	A (telescopic) mm	B mm	C mm	D mm	L/L1 mm
NS8300	930 +/- 100	665 +/- 100	800	940	3000/1625
NS8400	930 +/- 100	665 +/- 100	800	940	4000/2625

TAVOLI VIBRANTI SERIE "TAV"

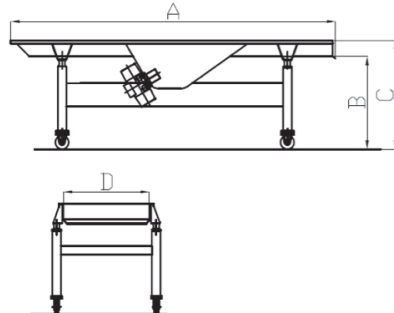

	A mm	B mm	C mm	D mm
TAV 8300	3000	855	1000	800
TAV 8400	4000	855	1000	800

TRAMOGGIA BINS STATICA "TRA"

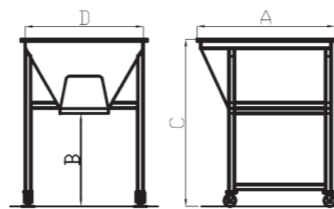

	A mm	B mm	C mm	D mm
TRA 500	1480	1000	1800	1270

LINEE RICEVIMENTO E SELEZIONE UVE



Mōri[®]
IMPIANTI ENOLOGICI

MORI LUIGI s.r.l. - Via Cassia, 42 - Fraz. Calzaiolo - 50026 SAN CASCIANO VAL DI PESA (FI)
Tel. +39 055 8249117 Fax +39 055 8249304 - www.moriluigi.it - E-mail: mori@moriluigi.it

Dati e misure non sono impegnativi e possono essere variati senza preavviso

Mōri[®]
IMPIANTI ENOLOGICI



 **Tramogge di ricezione vibranti** per scarico e dosaggio uve da casse e da bins. Costruzione inox, variatore elettronico di velocità di avanzamento, telaio su ruote e piedi regolabili. Modelli da 125-250 e 500 Kg.

 **Inox Vibrating hopper** for boxes and bins discharge. Electronic speed variator, inox frame on wheels and adjustable feet. -125, 250 and 500 Kg Version.

 **Trémie Vibrant de réception** inox avec inverter pour le discharge de casse et bins. Chassis avec roues et pieds réglables. 125-250 et 500 Kg.

 **Vibrationstrichter** zum Entladen und Dosieren von Weintrauben aus Kisten und Bins. Trichter aus Edelstahl, elektronischer drehzahlvariabler Antrieb zum Einstellen der Vorschubgeschwindigkeit, Gestell auf Rollen mit verstellbaren Stützen. Kpazität der Modelle 125 - 250 und 500 Kg.

 **Tolva de recepción vibrante** para uva, con variador electrónico de velocidad, construcción en acero inox. Ruedas y pied reglables. De 125, 250 y 500 Kg.



 Tavolo di selezione a nastro, variatore meccanico di velocità. Larghezza nastro 800 mm, lunghezza nastro 3000 e 4000 mm. Telaio inox su ruote, altezza regolabile con gambe telescopiche. Su richiesta corsie laterali per evacuazione scarti.



 Belt sorting table, inox frame on wheels, mechanical speed variator, 800 mm width with 3000 and 4000 mm length, with telescopic legs for height adjusting. Side lanes on demand.

 Tableau de sélection à bande, variateur de vitesse mécanique. 800 mm largeur de bande, bande longueur 3000 mm et 4000. Châssis en acier sur roues, hauteur réglables avec pattes télescopiques. Voies secondaires sur demande.

 Rütteltisch, Gestell aus Edelstahl, elektronischer drehzahlvariabler Antrieb, Gestell auf Rollen mit verstellbaren Stützen. Breite 800mm für 3000mm und 4000mm Länge. Auf Anfrage erhältlich: Ablauf mit Sieb, Most-Rückgewinnungswanne mit Pumpenanschluss und Seitenrinnen zur Abfallentfernung.

 Mesa de seleccion a cinta, variador de velocidad mecánico. 800 mm de ancho 3000 y 4000 mm de longitud. Estructura de acero inoxidable sobre ruedas con patas ajustables telescópicas. A petición corsia laterales

 **Nastri elevatori**, tappeto in PVC alimentare, telaio inox, variatore meccanico di velocità, quadro elettrico e pistone idraulico per regolazione altezza di scarico. Larghezza nastro 400mm per le versioni lunghezza 2500, 3000, 3500 e 4000 mm. Passaggio nastro ispezionabile anche internamente, attacco pompa per mosto e tappo di ispezione. Nastro da 250mm per la versione ECO lunghezza 2000 mm, altezza regolabile con piede telescopico, velocità fissa. Tramoggia per scarico bins.

 **PVC belt elevators**, S/S frame with pneumatic piston for discharging height adjusting, mechanical speed variator. Belt width 400 mm. on 2500, 3000, 3500 and 4000 mm length versions, 250mm width on 2000 mm length ECO version, with single speed and telescopic leg adjusting. Bins hopper.

 **Elévateur à bande** en PVC alimentaires, chassie en acier inox, à vitesse réglables avec variateur mécanique, roulement de bande inspectionable. Bac de récupération de jus avec sortie pour pompe, hauteur de décharge réglables avec pistons hydraulique. 400mm largeur 2500, 3000, 3500 et 4000 mm longueur. Version bande ECO 250mm largeur pour une longueur 2000 mm, hauteur de décharge réglables manuelle, à vitesse fixe. Trémie pour bins.

 **Schrägförderbänder**, PVC-Förderband für Lebensmittel, Gestell aus Edelstahl, mechanischer Geschwindigkeitsregler, elektrische Schalttafel und Hydraulikkolben zur Abwurfhöhenverstellung. Bandbreite 400mm für Versionen mit einer Länge von 2500, 3000, 3500 und 4000 mm. Zugang für interne Bandinspektion, Mostpumpenanschluss. Bandbreite 250mm für die Ausführung ECO 2000mm Länge, Abwurfhöhenverstellung mit Teleskopstütze, feste Drehzahl. Bins Beladetrichter.

 **Cinta Elevadora PVC**, Con Estructura de acero inox, variador de velocidad mecánico y pistón hidráulico para ajustar la altura de descargamiento. Ancho de la cinta 400mm para versiones 2500, 3000, 3500 y 4000 mm de longitud y 250mm ancho para versión ECO de 2000mm de longitud con velocidad fija y pie reglable. Pasaje cinta que se inspecciona internamente y salida para bomba. Tolva para bins.



 Tavolo di selezione vibrante, costruzione inox, variatore elettronico di velocità, telaio su ruote e piedi regolabili. Larghezza mm 800 per 3000 e 4000 mm di lunghezza. Su richiesta tratto sgrondante con setaccio e vaschetta di recupero mosto con attacco pompa e corsie laterali

 S/S Vibrator sorting table, frame on wheels and adjustable feet, electronic speed variator. Width 800 mm 3000 and 4000 mm length. On demand drainage section with must recovery hopper and pump outlet and side lanes.

 Table de trie vibrant en acier inox, avec roues et pieds réglables. Variateur électronique de vitesse, largeur 800 mm, pour 3000 et 4000 mm longueur. Sur demande bac de réception de jus avec grille d'égouttage et voies secondaires

 Sortierband, mechanischer Geschwindigkeitsregler. Bandbreite 800 mm, Bandlänge 3000 und 4000 mm. Gestell aus Edelstahl auf Rollen, Höhenverstellung mit Teleskopstützen.

 Mesa de seleccion vibrante inox, ruedas y pies regulables. Variador electrónico de velocidad, a pedida reilla de drenaje con tolva de recuperación y salida para bomba y corsia laterales. Medidas de 800mm ancho y 3000 - 4000 mm de longitud